

# VALERIE

by Giopato&Coombes

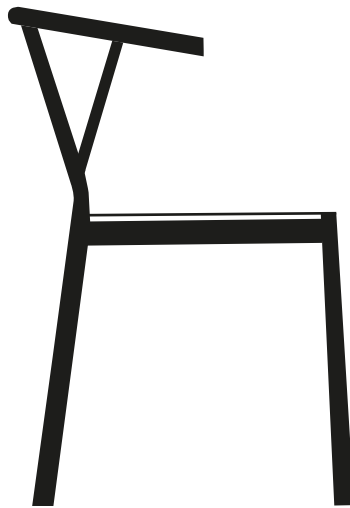

Seduta realizzata completamente in legno curvato. Vuole essere l'espressione dell'archetipo della seduta, sia per il materiale utilizzato che nella forma. Non vuole stupire, ma assolvere la sua funzione primaria: accogliere. La composizione si sviluppa nella contrapposizione tra la struttura essenziale e la seduta realizzata in legno curvato. Due linguaggi destinati ciascuno ad assolvere una funzione specifica, il supporto e il comfort.

The chair is made in bended wood. It represents the essence of the sitting archetype, due to the used materials and to the form. Doesn't want to impress, just to perform in the better way the primary function: to accommodate. The chair develops the contrast between the essential structure and the wooden seat: the first devoted to the support and the second, to the comfort.

## DIMENSIONI | DIMENSIONS

lunghezza | width: 59 cm

larghezza | depth: 55 cm

altezza | height 78 cm

altezza del sedile | seat height: 42,7 cm

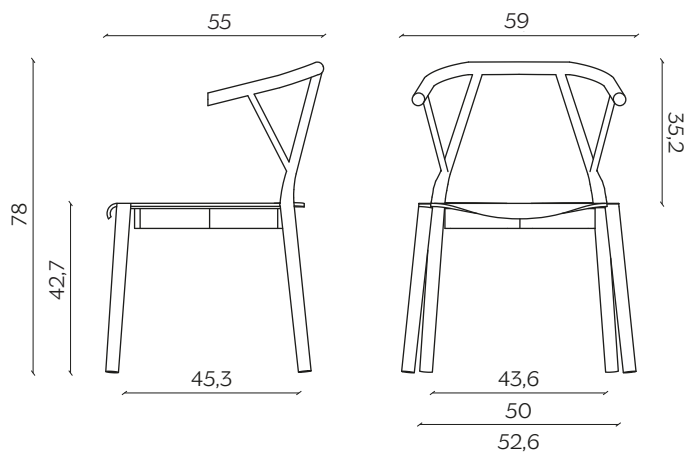

## AMBIENTE | ENVIRONMENT

interno | indoor

## DOWNLOAD | DOWNLOADS

la guida Cura e Manutenzione è disponibile su [miniforms.com](http://miniforms.com)  
Care and Maintenance guide is available at [miniforms.com](http://miniforms.com)

file 2D, 3D e fotografie sono disponibili su [miniforms.com](http://miniforms.com)  
2D, 3D files and hi-res images are available at [miniforms.com](http://miniforms.com)

## FINITURE | FINISHES

LEGNO | WOOD

### Struttura | Structure



Rovere Fiammato  
Flamed Oak



Rovere Tinto Noce  
Oak Stained Walnut



Rovere Nero  
Black Oak

# FINITURE | FINISHES

## TESSUTI | FABRICS

A

### Fluxo Bloom Ecoleather



Avorio  
Ivory



Bianco  
White



Rosso  
Red

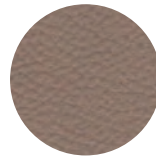

Tortora  
Dove Grey

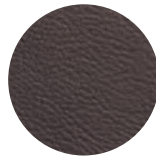

Testa di Moro  
Dark Brown

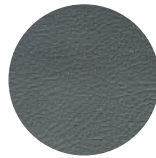

Grigio Scuro  
Dark Grey



Nero  
Black

### Tramè



Beige

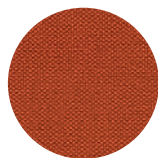

Arancio  
Orange

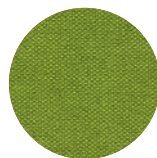

Mela  
Apple

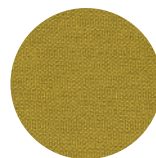

Senape  
Mustard

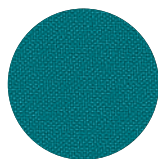

Pavone  
Peacock

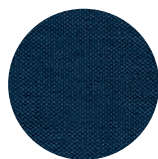

Blu Elettrico  
Electric Blue



Nero  
Black

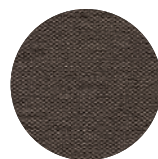

Grigio Scuro  
Dark Grey

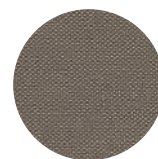

Tortora  
Dove Grey

### Madrid

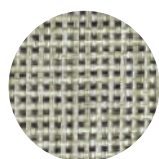

Burro  
Butter

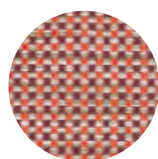

Melograno  
Pomegranate

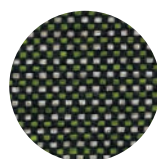

Menta  
Mint

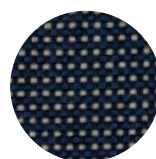

Notte  
Night

## TESSUTI | FABRICS

A

### Salò

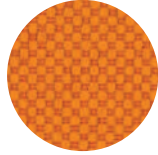

Arancio  
Orange

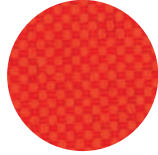

Rosso  
Red

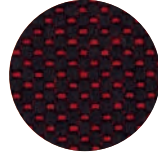

Marmellata  
Jam

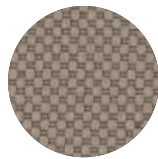

Grigio Chiaro  
Light Grey



Marrone  
Brown

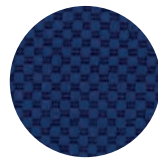

Blu Notte  
Midnight Blue

### Loop

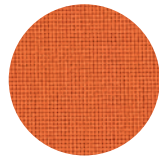

Arancione  
Orange

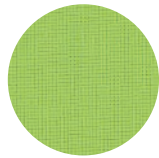

Lime

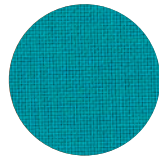

Turchese  
Turquoise

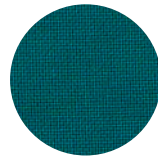

Ottanio  
Teal Green

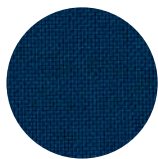

Blu Scuro  
Dark Blue



Testa di Moro  
Dark Brown

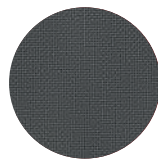

Grigio Fumo  
Smoke Grey

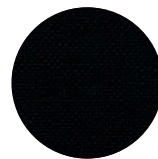

Nero  
Black

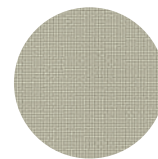

Avorio  
Ivory

# FINITURE | FINISHES

## TESSUTI | FABRICS

B

### Fluxo Rebel Econabuk



Seppia  
Sepia



Nocciola  
Light Brown



Marrone  
Brown



Grigio  
Grey



Antracite  
Anthracite

### Fluxo Platinum



Pesca  
Peach



Nocciola  
Hazelnut

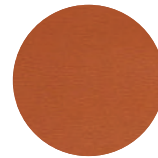

Mattone  
Brick

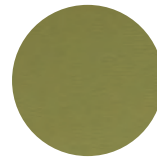

Verde  
Green



Nuvoloso  
Cloudy

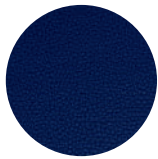

Blu  
Blue



Porpora  
Purple

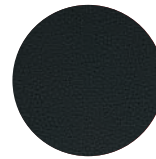

Nero  
Black

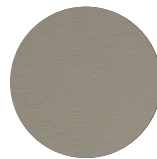

Tortora  
Dove Grey

### Mesh

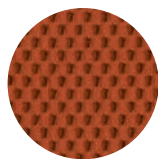

Rosso Corallo  
Coral Red



Verde Salvia  
Sage Green

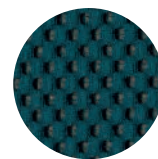

Foglia di Tè  
Teal

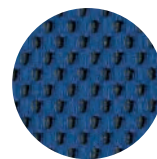

Blu Neon  
Neon Blue

# TESSUTI | FABRICS

B

## Kvadrat Relate



Rosa  
Pink

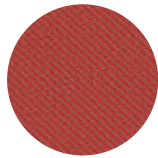

Rosso  
Red

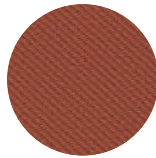

Terra  
Ground

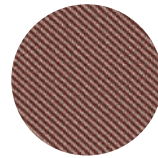

Snack

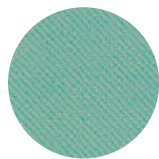

Menta  
Mint

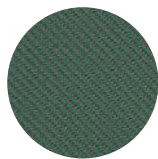

Verde Bosco  
Forest Green

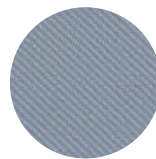

Nuvolo  
Cloudy

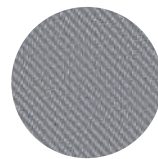

Crigio  
Grey

## Torilana Cubbio

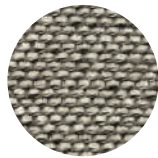

Sale e Pepe  
Salt and Pepper

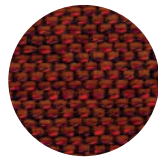

Ambra  
Amber

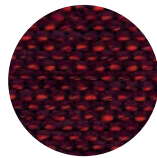

Bordeaux

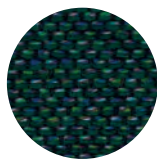

Verde Petrolio  
Petrol Green

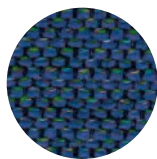

Blu Elettrico  
Electric Blue



Castagna  
Walnut

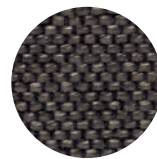

Tortora  
Dove Grey

## Lanee



Crigio  
Grey

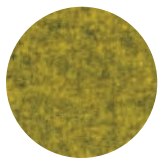

Giallo  
Yellow

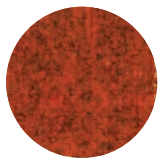

Rosso  
Red

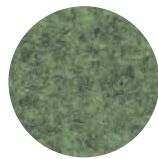

Menta  
Mint

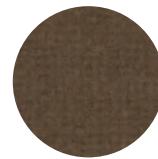

Marrone  
Brown

# TESSUTI | FABRICS

B

## Vescom Wilson

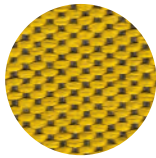

Ciallo Elettrico  
Electric Yellow

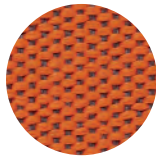

Energico  
Energetic

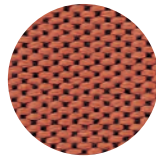

Rosé

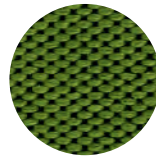

Laguna  
Lagoon

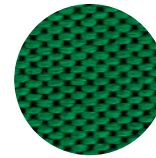

Prato  
Field

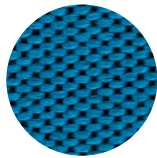

Zaffiro  
Sapphire

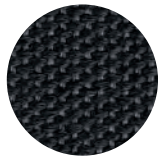

Grafite  
Graphite

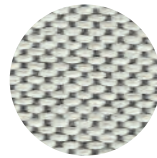

Sale e Pepe  
Salt and Pepper

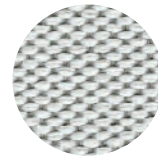

Neve  
Snow

## Vescom Norfolk

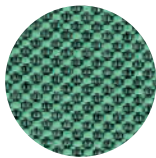

Latte e Menta  
Milk and Mint

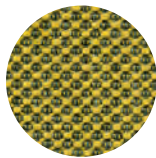

Ape  
Bee

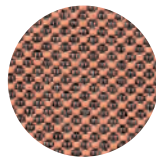

Rosa  
Pink



Mattone  
Brick

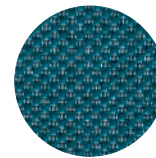

Petrolio  
Petrol-Green

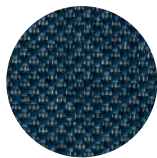

Notte  
Night



Antracite  
Anthracite



Sale e Pepe  
Salt and Pepper

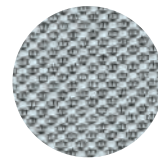

Ghiaccio  
Ice



# FINITURE | FINISHES

## TESSUTI | FABRICS

C

### Shelter Velvet



Crema  
Cream



Rosa Intenso  
Intense Rose



Terra di Siena  
Burnt Sienna



Cammello  
Camel



Verde  
Green

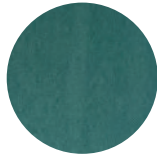

Turchese  
Turquoise

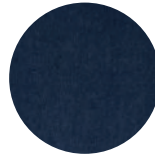

Blu Notte  
Midnight Blue



Testa di Moro  
Dark Brown

### Kvadrat Field 2

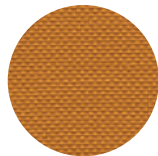

Zafferano  
Saffron-Yellow

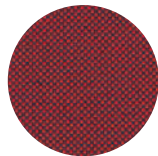

Ciliegia  
Cherry

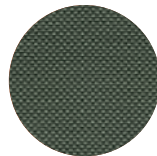

Menta  
Mint

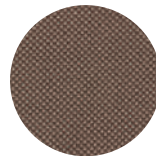

Nocciola  
Hazel

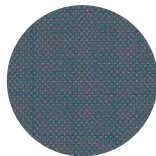

Zucchero  
Sugar

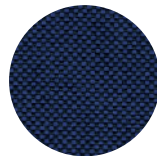

Blu  
Blue

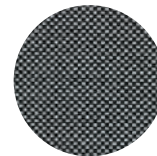

Sale e Pepe  
Salt and Pepper

### Torrilana Brionne



Black and White

## TESSUTI | FABRICS

C

### Vescom Harding

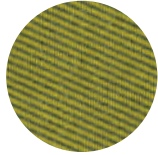

Ciallo  
Yellow

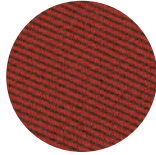

Rosso  
Red

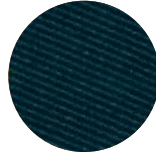

Petrolio  
Blue-Green

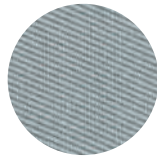

Grigio Chiaro  
Light Grey

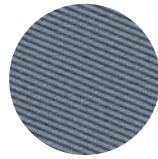

Nuvolo  
Cloudy

### Vescom Rolla

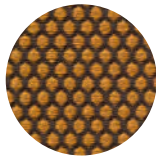

Mostarda  
Mustard

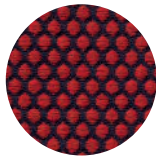

Ciliegia  
Cherry

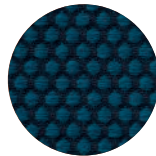

Blu Pavone  
Peacock

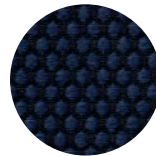

Blu Notte  
Midnight Blue

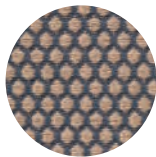

Latte  
Steamed Milk

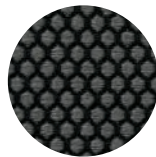

Antracite  
Anthracite

### Torrilana Rakam



Bacca  
Berry

# FINITURE | FINISHES

## TESSUTI | FABRICS

D

### Cloud



Panna  
Cream

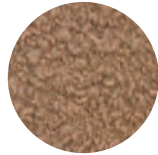

Noce  
Walnut

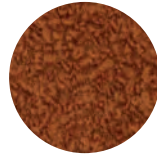

Nocciola  
Hazelnut

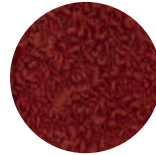

Bordeaux

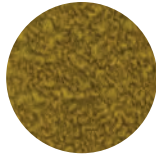

Senape  
Mustard

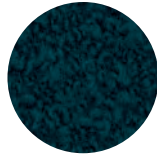

Petrolio  
Blue-Green

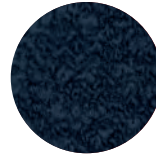

Blu Notte  
Night Blue

### Maharam Merit

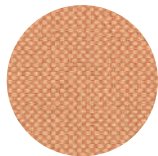

Salmone  
Salmon

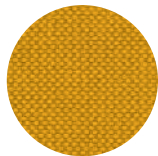

Ciallo  
Yellow

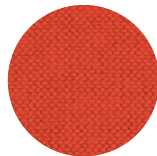

Rosso Corallo  
Coral Red

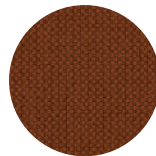

Marrone  
Brown

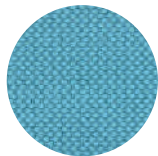

Celeste  
Sky Blue

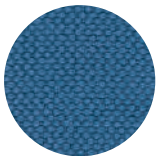

Blu Cobalto  
Cobalt Blue

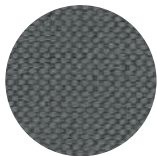

Grigio  
Grey

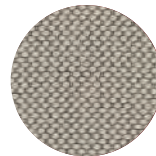

Sale e Pepe  
Salt and Pepper

TESSUTI | FABRICS

D

Rohi Sera

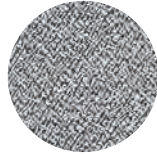

Pepper

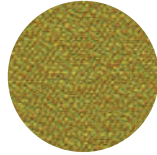

Tivoli

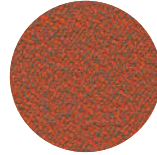

Clow

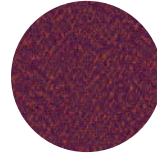

Berry

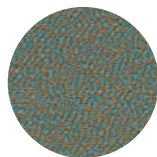

Mirage

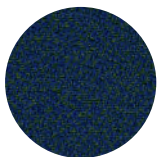

Mare

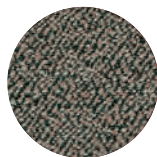

Walnut



Rosewood

Rohi Mica

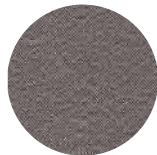

Pepper

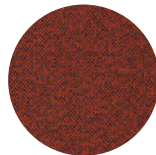

Indio

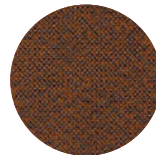

Amber

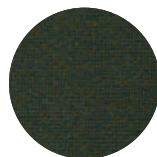

Jungle

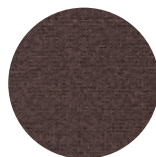

Mud

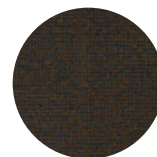

Secret

FINITURE | FINISHES  
TESSUTI | FABRICS

E

Kvadrat Steelcut Trio 3



Arancia Rossa  
Red Orange

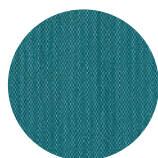

Pavone  
Peacock



Pesca  
Peach



Sale e Pepe  
Salt and Pepper



Elettricità  
Electricity

# VALERIE WITH ARMREST

by Giopato&Coombes

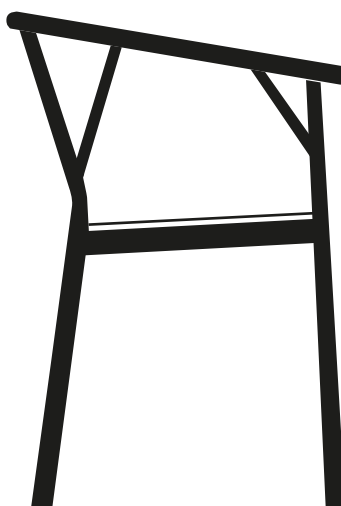

Seduta realizzata completamente in legno curvato. Vuole essere l'espressione dell'archetipo della seduta, sia per il materiale utilizzato che nella forma. Non vuole stupire, ma assolvere la sua funzione primaria: accogliere. La composizione si sviluppa nella contrapposizione tra la struttura essenziale e la seduta realizzata in legno curvato. Due linguaggi destinati ciascuno ad assolvere una funzione specifica, il supporto e il comfort.

The chair is made in bended wood. It represents the essence of the sitting archetype, due to the used materials and to the form. Doesn't want to impress, just to perform in the better way the primary function: to accommodate. The chair develops the contrast between the essential structure and the wooden seat: the first devoted to the support and the second, to the comfort.

## DIMENSIONI | DIMENSIONS

lunghezza | width: 59,5  
larghezza | depth: 55 cm  
altezza | height: 78 cm  
altezza del sedile | seat height: 42,7 cm

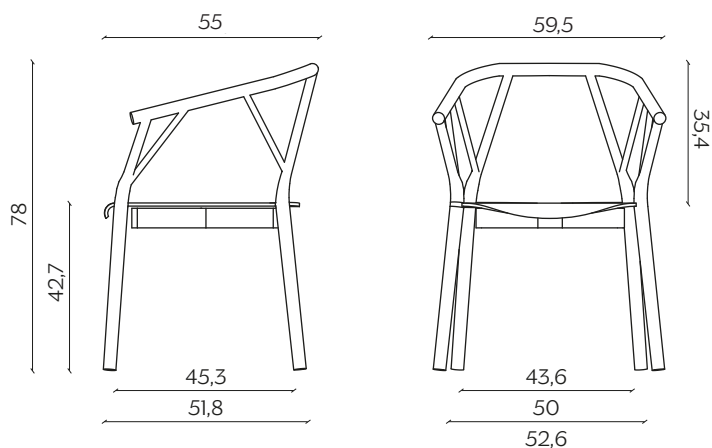

## AMBIENTE | ENVIRONMENT

interno | indoor

## DOWNLOAD | DOWNLOADS

la guida Cura e Manutenzione è disponibile su [miniforms.com](https://miniforms.com)  
Care and Maintenance guide is available at [miniforms.com](https://miniforms.com)

file 2D, 3D e fotografie sono disponibili su [miniforms.com](https://miniforms.com)  
2D, 3D files and hi-res images are available at [miniforms.com](https://miniforms.com)

## FINITURE | FINISHES

LEGNO | WOOD

### Struttura | Structure



Rovere Fiammato  
Flamed Oak



Rovere Tinto Noce  
Oak Stained Walnut



Rovere Nero  
Black Oak



# FINITURE | FINISHES

## TESSUTI | FABRICS

A

### Fluxo Bloom Ecoleather



Avorio  
Ivory



Bianco  
White

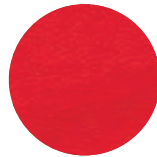

Rosso  
Red

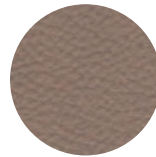

Tortora  
Dove Grey



Testa di Moro  
Dark Brown

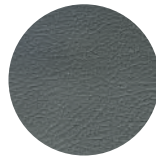

Grigio Scuro  
Dark Grey



Nero  
Black

### Tramè



Beige

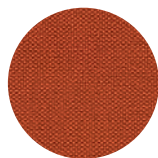

Arancio  
Orange

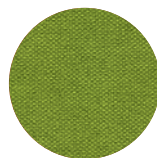

Mela  
Apple

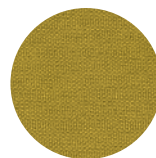

Senape  
Mustard

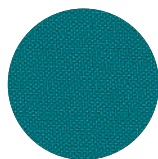

Pavone  
Peacock

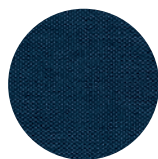

Blu Elettrico  
Electric Blue



Nero  
Black

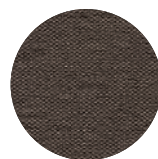

Grigio Scuro  
Dark Grey

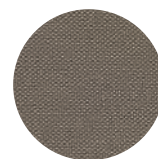

Tortora  
Dove Grey

### Madrid

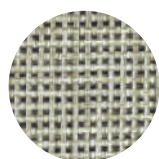

Burro  
Butter

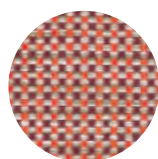

Melograno  
Pomegranate

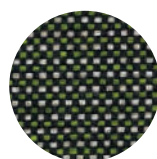

Menta  
Mint

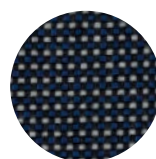

Notte  
Night

## TESSUTI | FABRICS

A

### Salò

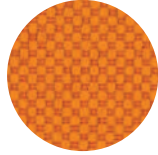

Arancio  
Orange

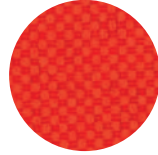

Rosso  
Red

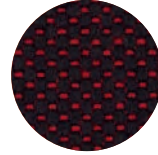

Marmellata  
Jam

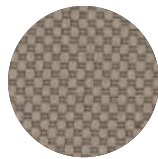

Grigio Chiaro  
Light Grey



Marrone  
Brown

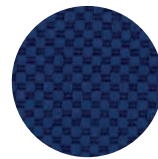

Blu Notte  
Midnight Blue

### Loop

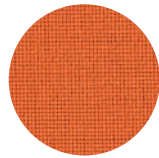

Arancione  
Orange



Lime

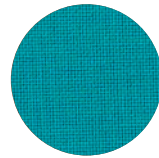

Turchese  
Turquoise

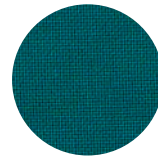

Ottanio  
Teal Green

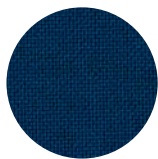

Blu Scuro  
Dark Blue



Testa di Moro  
Dark Brown

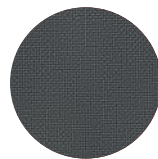

Grigio Fumo  
Smoke Grey



Nero  
Black



Avorio  
Ivory

# FINITURE | FINISHES

## TESSUTI | FABRICS

B

### Fluxo Rebel Econabuk



Seppia  
Sepia



Nocciola  
Light Brown



Marrone  
Brown



Grigio  
Grey



Antracite  
Anthracite

### Fluxo Platinum



Pesca  
Peach



Nocciola  
Hazelnut

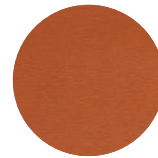

Mattone  
Brick

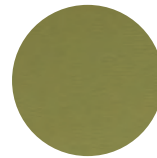

Verde  
Green



Nuvoloso  
Cloudy

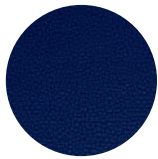

Blu  
Blue



Porpora  
Purple



Nero  
Black

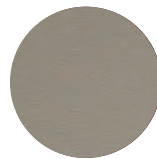

Tortora  
Dove Grey

### Mesh

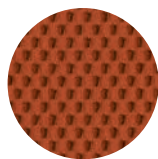

Rosso Corallo  
Coral Red

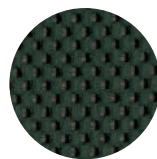

Verde Salvia  
Sage Green

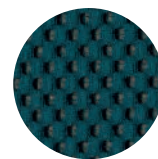

Foglia di Tè  
Teal

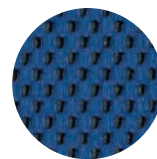

Blu Neon  
Neon Blue

# TESSUTI | FABRICS

B

## Kvadrat Relate



Rosa  
Pink

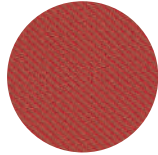

Rosso  
Red

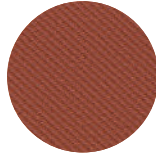

Terra  
Ground

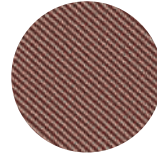

Snack

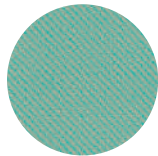

Menta  
Mint

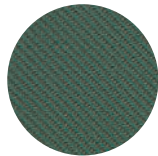

Verde Bosco  
Forest Green

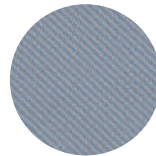

Nuvolo  
Cloudy



Crigio  
Grey

## Torrilana Cubbio

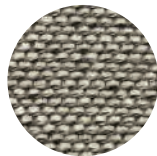

Sale e Pepe  
Salt and Pepper

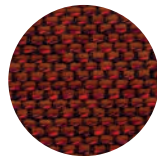

Ambra  
Amber

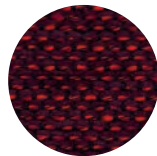

Bordeaux

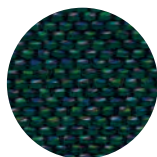

Verde Petrolio  
Petrol Green

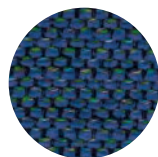

Blu Elettrico  
Electric Blue



Castagna  
Walnut

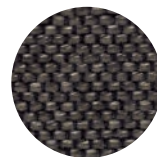

Tortora  
Dove Grey

## Lanee



Crigio  
Grey

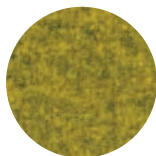

Giallo  
Yellow

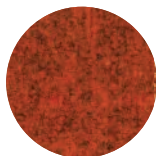

Rosso  
Red

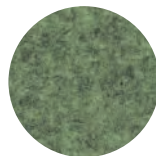

Menta  
Mint

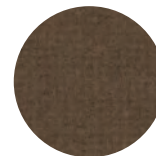

Marrone  
Brown

# TESSUTI | FABRICS

B

## Vescom Wilson

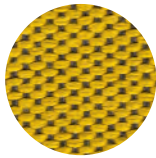

Ciallo Elettrico  
Electric Yellow

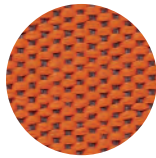

Energico  
Energetic

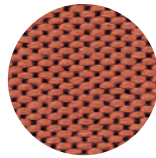

Rosé

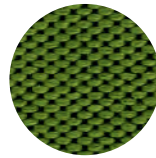

Laguna  
Lagoon

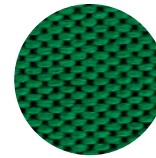

Prato  
Field

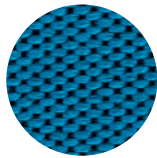

Zaffiro  
Sapphire

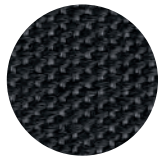

Grafite  
Graphite

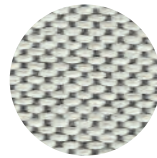

Sale e Pepe  
Salt and Pepper

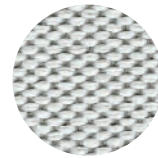

Neve  
Snow

## Vescom Norfolk

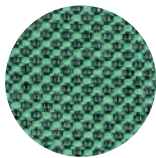

Latte e Menta  
Milk and Mint

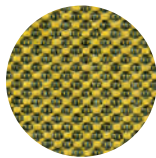

Ape  
Bee

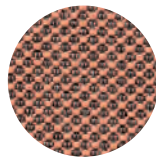

Rosa  
Pink



Mattone  
Brick

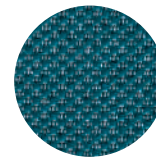

Petrolio  
Petrol-Green

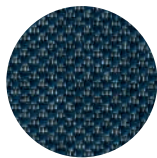

Notte  
Night



Antracite  
Anthracite



Sale e Pepe  
Salt and Pepper

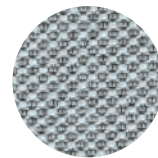

Ghiaccio  
Ice

# FINITURE | FINISHES

## TESSUTI | FABRICS

C

### Shelter Velvet



Crema  
Cream



Rosa Intenso  
Intense Rose



Terra di Siena  
Burnt Sienna



Cammello  
Camel

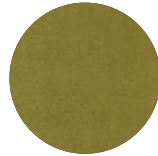

Verde  
Green

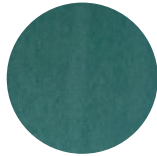

Turchese  
Turquoise



Blu Notte  
Midnight Blue



Testa di Moro  
Dark Brown

### Kvadrat Field 2

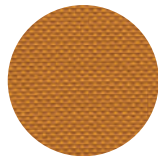

Zafferano  
Saffron-Yellow

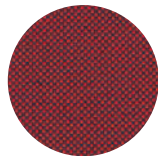

Ciliegia  
Cherry

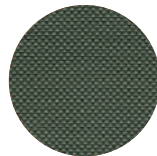

Menta  
Mint

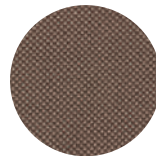

Nocciola  
Hazel

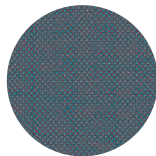

Zucchero  
Sugar

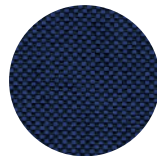

Blu  
Blue

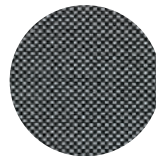

Sale e Pepe  
Salt and Pepper

### Torrilana Brionne



Black and White



## TESSUTI | FABRICS

C

### Vescom Harding

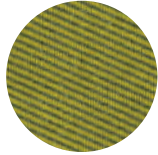

Ciallo  
Yellow

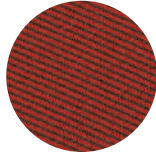

Rosso  
Red

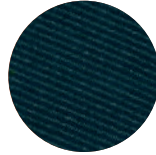

Petrolio  
Blue-Green

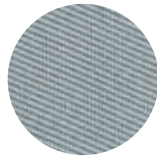

Grigio Chiaro  
Light Grey

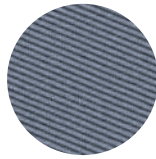

Nuvolo  
Cloudy

### Vescom Rolla

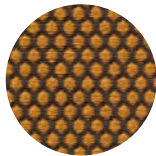

Mostarda  
Mustard

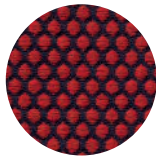

Ciliegia  
Cherry

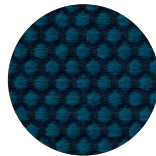

Blu Pavone  
Peacock

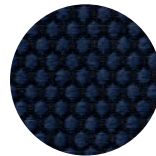

Blu Notte  
Midnight Blue

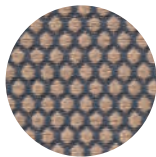

Latte  
Steamed Milk

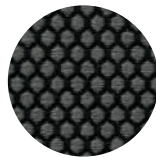

Antracite  
Anthracite

### Torrilana Rakam



Bacca  
Berry

# FINITURE | FINISHES

## TESSUTI | FABRICS

D

### Cloud



Panna  
Cream

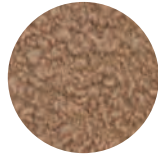

Noce  
Walnut

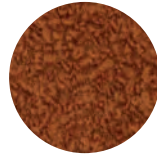

Nocciola  
Hazelnut

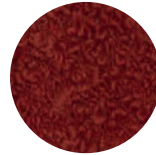

Bordeaux

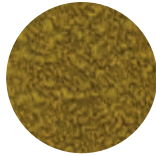

Senape  
Mustard

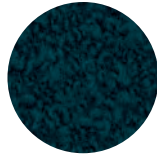

Petrolio  
Blue-Green

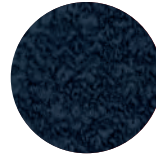

Blu Notte  
Night Blue

### Maharam Merit

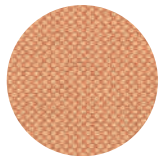

Salmone  
Salmon

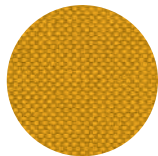

Ciallo  
Yellow

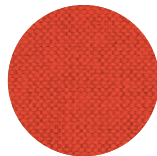

Rosso Corallo  
Coral Red

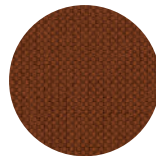

Marrone  
Brown

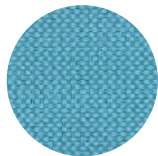

Celeste  
Sky Blue

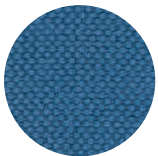

Blu Cobalto  
Cobalt Blue

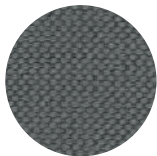

Grigio  
Grey

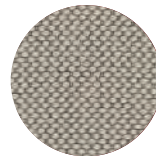

Sale e Pepe  
Salt and Pepper



TESSUTI | FABRICS

D

Rohi Sera

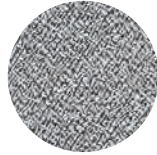

Pepper

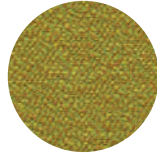

Tivoli

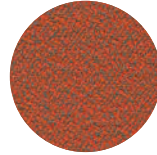

Clow

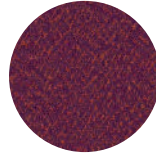

Berry

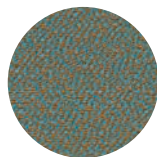

Mirage

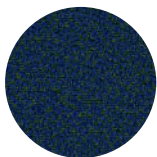

Mare

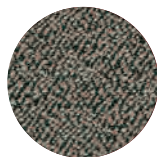

Walnut



Rosewood

Rohi Mica

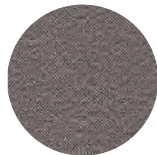

Pepper

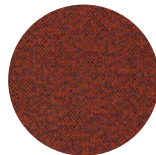

Indio

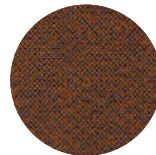

Amber

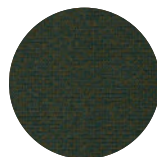

Jungle

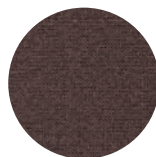

Mud

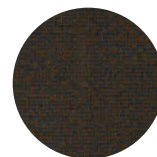

Secret

FINITURE | FINISHES  
TESSUTI | FABRICS

E

Kvadrat Steelcut Trio 3

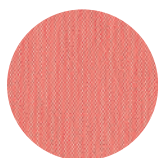

Arancia Rossa  
Red Orange

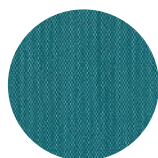

Pavone  
Peacock



Pesca  
Peach



Sale e Pepe  
Salt and Pepper



Elettricità  
Electricity